

# Unilite Opto Technology

*email: info@unilite-tech.com*

## U-P3528G-05



### ■ Description

The PLCC2 type U-P3528 0.5W GREEN TOP VIEW LED, with its light weight , enables small board size, higher packing density, reduced storage space and miniature applications.

- Dice Material : InGaN
- Light Color : Green
- Lens Color : Water Clear

### ■ Features

- 1 chips package
- Compatible with automatic placement equipment
- Compatible with reflow soldering process
- Long operating life
- Low forward voltage operated
- Instant light
- Pb -free/ RoHS compliant

### ■ Applications

- Information boards
- Automotive Interior Lighting
- Indoor and outdoor display
- Indicator
- Backlighting
- Light bar
- Gernal applications

# Unilite Opto Technology

email: [info@unilite-tech.com](mailto:info@unilite-tech.com)

## U-P3528G-05

### ■ Outline Dimensions ( mm )

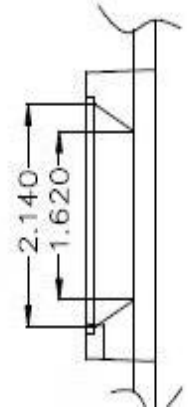
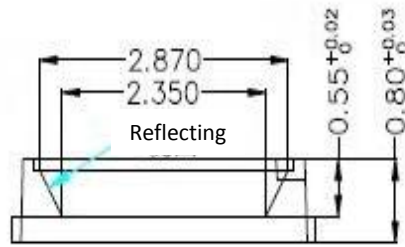
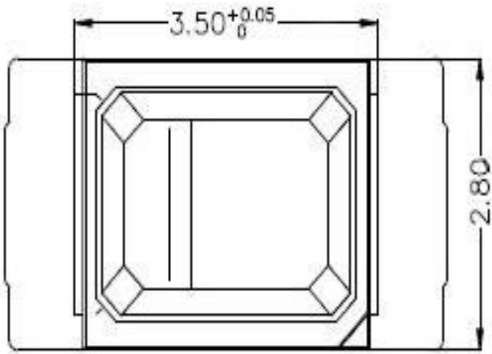

Tolerance :  $\pm 0.25$  mm

### ■ Recommend Soldering Pad ( mm )

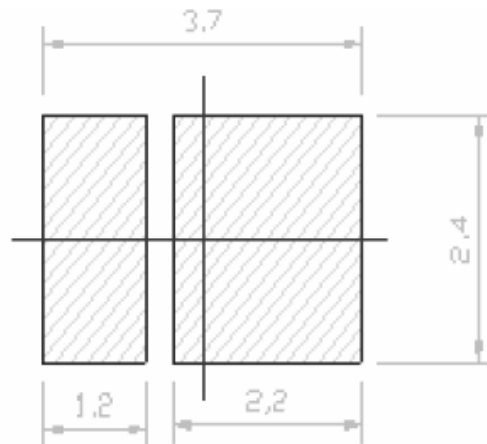
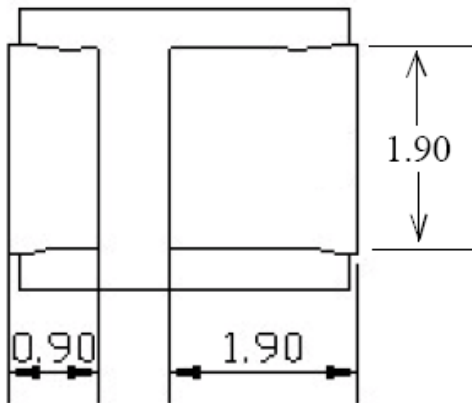

### ■ Part Numbering System

**U - P 3 5 2 8 G - 05**

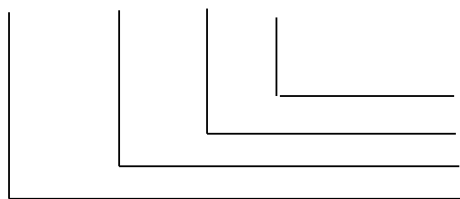

Wattage:0.5W  
Color code: Green  
Package code  
Product code

# Unilite Opto Technology

email: [info@unilite-tech.com](mailto:info@unilite-tech.com)

## U-P3528G-05

### ■ Absolute Maximum Ratings at Ta = 25 °C

PARAMETER	symbol	MAX.	UNIT
Power Dissipation *	PD	400	mW
Continuous Forward Current *	IF	180	mA
Peak Forward Current ( 1/10 Duty Cycle , 0.1ms Pulse Width ) *	IFP	300	mA
Reverse Voltage	VR	5	V
Operating Temperature Range	Topr	-30 to + 85	°C
Storage Temperature Range	Tstg	-40 to + 100	°C
Reflow Soldering Condition	Tsld	260 °C for 10 sec. 2 time.	

### ■ Electro-Optical Characteristics

Condition :  $I_F = 150\text{mA}$  ,  $T_a = 25^\circ\text{C}$

PARAMETER	SYMBOL	TEST CONDITION	VALUES			UNIT
			MIN.	TYP.	MAX.	
* Forward Voltage	$V_F$	$I_F=150\text{mA}$	2.8	3.2	3.6	V
Reverse Current	$I_R$	$V_R= 5\text{V}$			10	$\mu\text{A}$
Wavelength	$\lambda_D$	$I_F=150\text{mA}$	515	525	530	nm
Luminous Intensity	$I_m$	$I_F=150\text{mA}$	25		30	lm
Viewing Angle	2θ 1/2	$I_F=150\text{mA}$		120		Deg.

### ■ Bin Grade Limits ( $I_F = 150\text{ mA}$ ) Forward Voltage / v

Bin Code	Min	Max	Unit
V16	1.6	1.8	V
V18	1.8	2.0	V
V20	2.0	2.2	V
V22	2.2	2.4	V
V24	2.4	2.6	V
V26	2.6	2.8	V
V28	2.8	3.0	V
V30	3.0	3.2	V
V32	3.2	3.4	V
V33	3.4	3.6	V
V34	3.6	3.8	V

# Unilite Opto Technology

email: [info@unilite-tech.com](mailto:info@unilite-tech.com)

## U-P3528G-05

### ■ Typical Electro-Optical Characteristics Curve

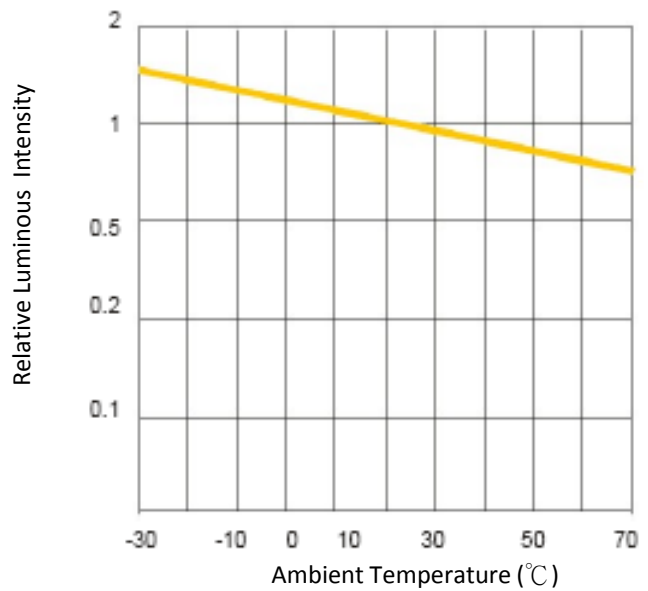
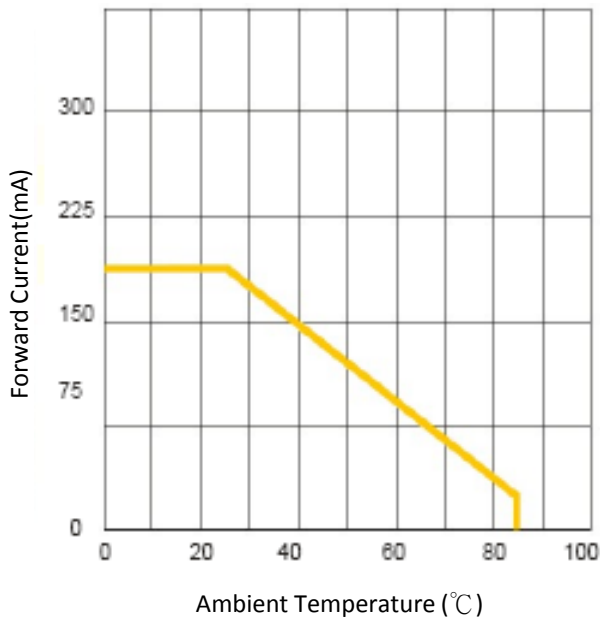
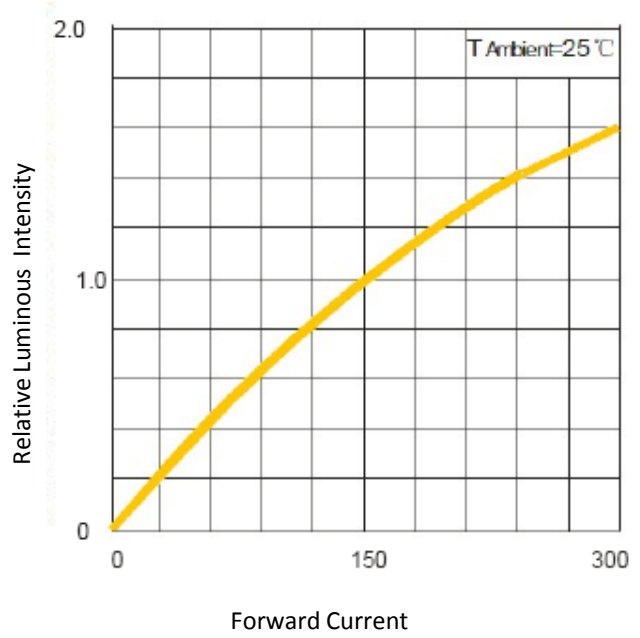
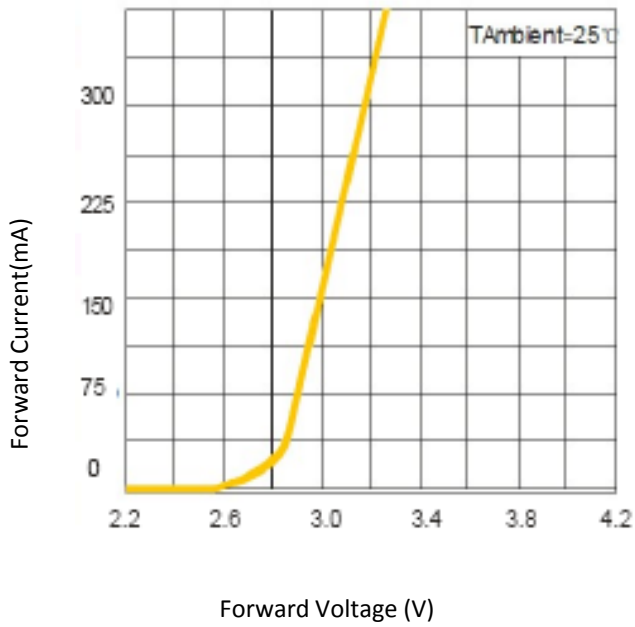

urrent(mA)

# Unilite Opto Technology

email: [info@unilite-tech.com](mailto:info@unilite-tech.com)

## U-P3528G-05

### ■ Typical Electro-Optical Characeristics Curve

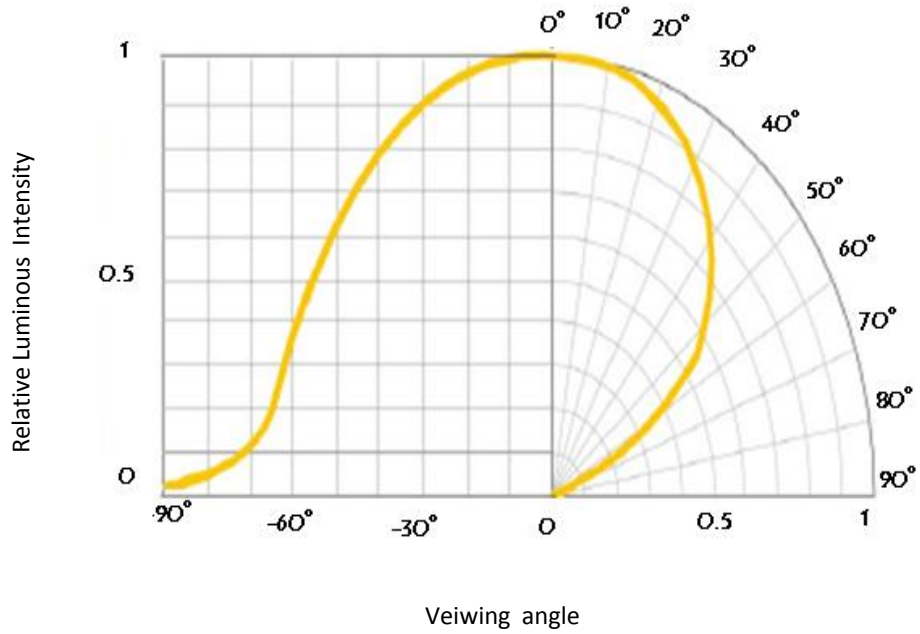
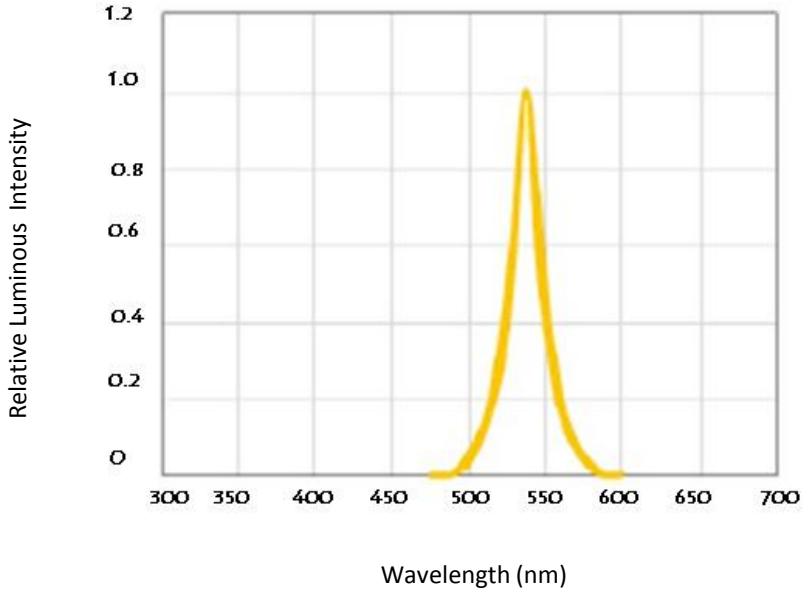

# Unilite Opto Technology

email: [info@unilite-tech.com](mailto:info@unilite-tech.com)

## U-P3528G-05

### ■ Carrier Type Dimensions

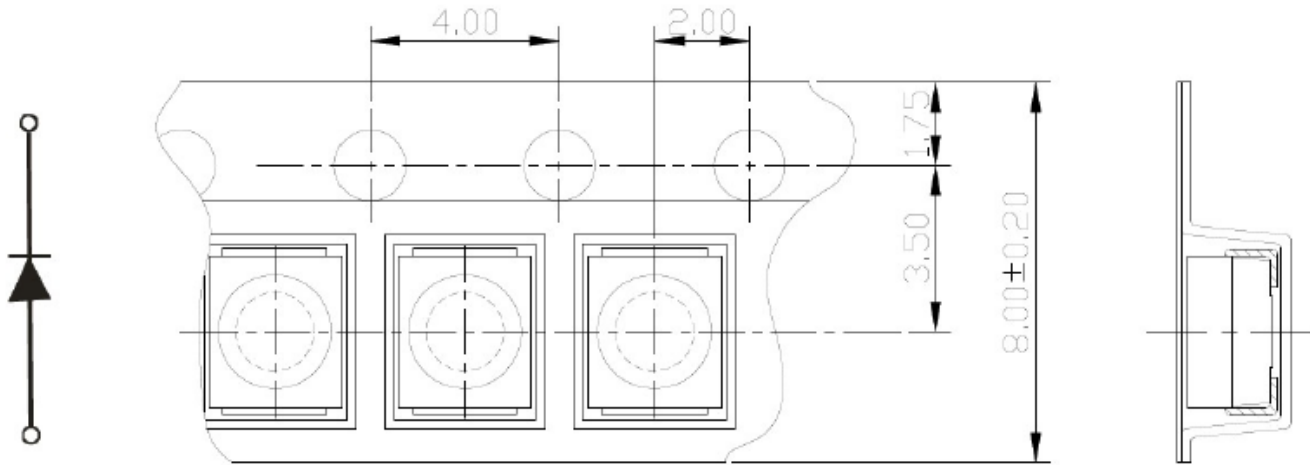

### ■ Reel Dimensions

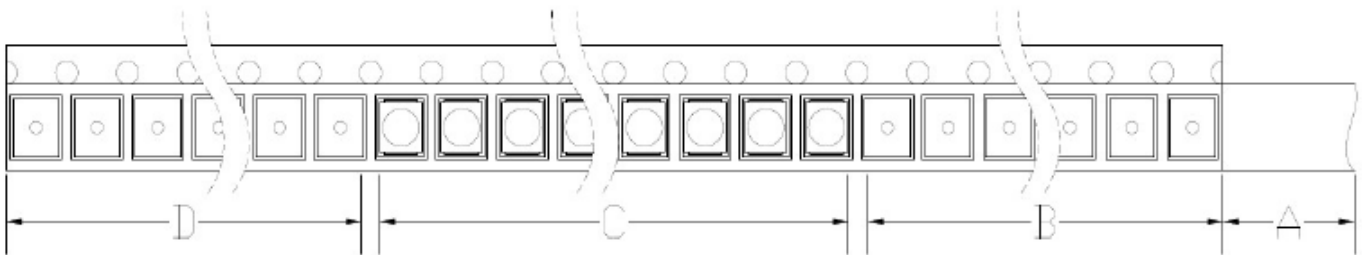

A: Top Cover Tape, 300mm; B: Leader, Empty, 200mm; C: 2000 Lamps Loaded; D: Trailer, Empty, 200mm.

A: The Cover Tape: 300mm

B: Leader, Empty: 200mm

C: LED quantity: 2000pcs

D: Trailer, Empty: 200mm

# Unilite Opto Technology

*email: info@unilite-tech.com*

## U-P3528G-05

### ■ Cautions

#### (1) Moisture Proof Package

- A) The moisture proof package, a plastic bag with a zipper, is used to keep moisture to a minimum in the package.
- B) A package of a moisture absorbent material (silica gel) is also inserted into the plastic moisture proof bag and the silica gel changes its color from blue to pink as it absorbs moisture.
- C) The absorbed moisture in the SMT package may vaporize and expand during soldering. This may cause exfoliation of the contacts and damage to the optical characteristics of the LEDs.

#### (2) Storage Conditions

- A) Before opening the package :  
The LEDs should be kept at 30°C or less and 45~60% RH or less and should be used within a year. When storing the LEDs, moisture proof package with absorbent material (silica gel) is recommended.
- B) After opening the package :  
The LEDs should be kept at 30°C or less and 55% RH or less and should be soldered within 168 hours (7days) after opening the package. The unused LEDs should be stored in moisture proof packages.
- C) It's also recommended to return the LEDs to the original moisture proof bag and to reseal the moisture proof bag again.
- D) If the moisture absorbent material (silica gel) has faded away or the SMD LEDs have exceeded the storage time, baking treatment ( more than 24 hours at 65+/-5°C) should be performed before soldering.

#### (3) Heat Generation

- A) The thermal design of the end product is very important. It is necessary to avoid intense heat generation and operate within the maximum ratings given in this specification.
- B) The operating current should be decided after considering the ambient maximum temperature of LEDs.

#### (4) Cleaning

- A) Isopropyl alcohol is recommended to be used as a solvent for cleaning the LEDs.
- B) Before cleaning, a pre-test should be done to confirm whether any damage to the LEDs will occur.

# Unilite Opto Technology

email: [info@unilite-tech.com](mailto:info@unilite-tech.com)

## U-P3528G-05

### (5) Soldering

Reflow Soldering ( recommended ) :

- A) To prevent from cracking, please bake ( 65°C , 24hrs ) before soldering.
- B) When soldering, do not load stress on the LEDs during heating.
- C) Never take next process until the component is cooled down to room temperature after reflow.
- D) After soldering, do not warp the circuit board.
- E) The recommended reflow soldering profile ( measuring on the surface of the LED resin ) is the following:

#### (a) Lead-Free Solder

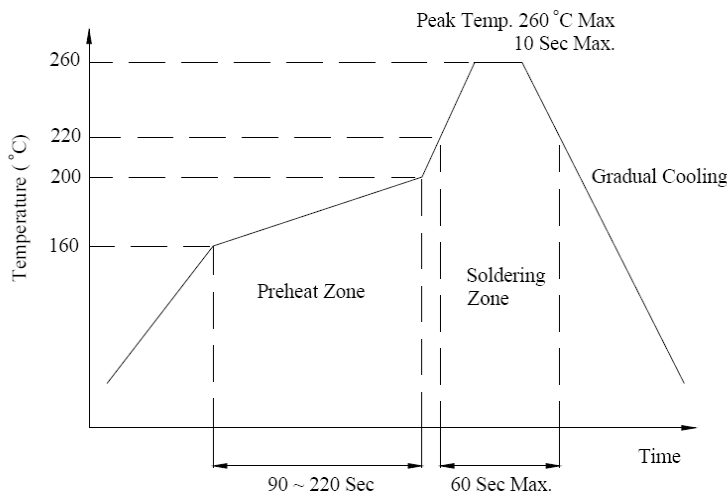

#### (b) Lead Solder

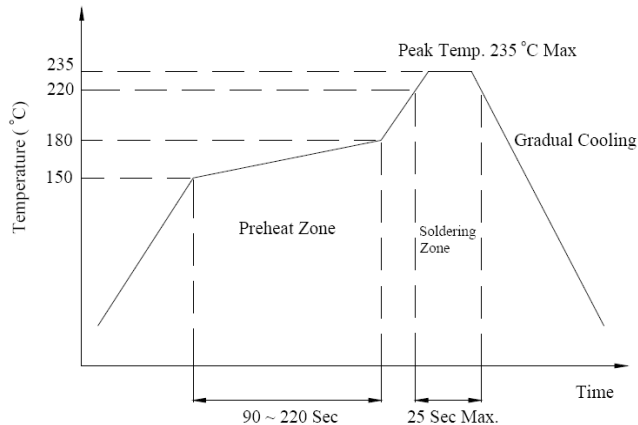

Manual Soldering ( not recommended ) :

- A) To prevent from cracking, please bake ( 65°C , 24hrs ) before soldering.
- B) Temperature at tip of iron: 250°C Max. ( 25W ).
- C) It's banned to load any stress on the resin during soldering.
- D) Soldering time: 3 sec. Max.( one time only ).



# Unilite Opto Technology

*email: info@unilite-tech.com*

## U-P3528G-05

- (6) ESD ( electrostatic discharge ) protection ( base on machine mode )
- A) The product is Gallium Nitride ( GaN ) based light emitting diode ( LED ) and is extremely sensitive to ESD. Users are strongly recommended to take necessary meter to test the static electricity and avoid ESD when handling this product.
  - B) Proper grounding of machines ( via  $1M\Omega$  ), using static dissipative mats, containers, working uniforms and shoes are considered to be effective against ESD.
  - C) An ionizer is recommended in the facility or environment where ESD may be generated easily, and soldering iron with a grounded tip is also recommended.
  - D) When inspecting the final products in which LEDs are assembled, it is recommended to check whether the assembled LEDs are damaged by ESD or not. It is simple to find damaged LEDs by light-on or VF test at lower current ( below 1mA is recommended ).
  - E) ESD damaged LEDs will show some unusual characteristics such as the remarkable increasing of leak current, the decreasing of forward voltage, or the LEDs do not light on at the low current.
- (7) Other
- A) Care must be taken to ensure that the reverse voltage will not exceed the absolute maximum rating when using the LEDs with matrix drive.
  - B) The LED light output is strong enough to injure human eyes. Precaution must be taken to prevent looking directly at the LEDs with unaided eyes for more than a few seconds.
  - C) The LEDs described here are intended to be used for ordinary electronic equipment, please consult Unilite Opto in advance for information on applications.
  - D) Installing a protection device in the LED driving circuit to avoid surge current exceeding the max rating during on/off switching.
  - E) The appearance and specifications of the product may be modified for improvement without notice.
  - F) Please use the product within 168 hours after opening the seal and keep under 30 °C and 70% humidity.
  - G) Unilite Opto Technology will not be responsible for any claim for damage if the user use the product without following the caution or instruction of the specification.